

vestre

Habitats

Birdhouse

Article no: 5825

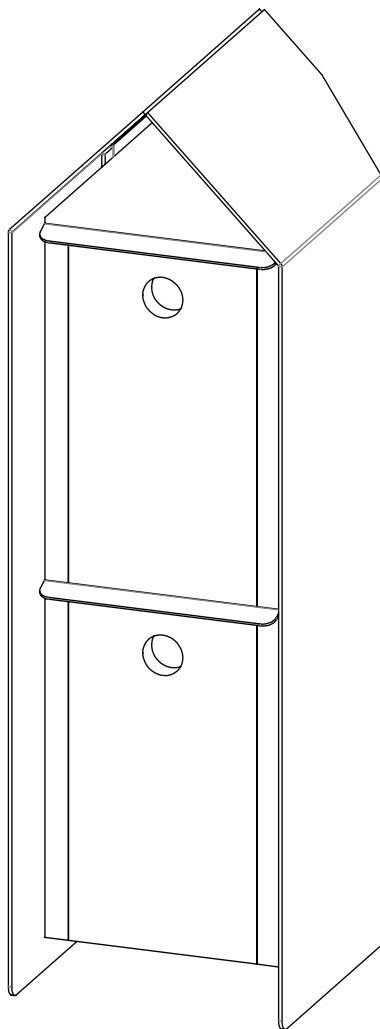

10 Kg

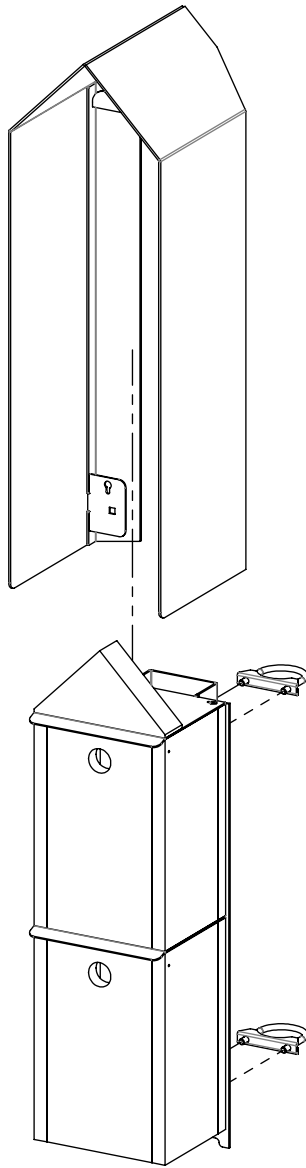

2x M8



